

TOLERANCE +3/-3 mm

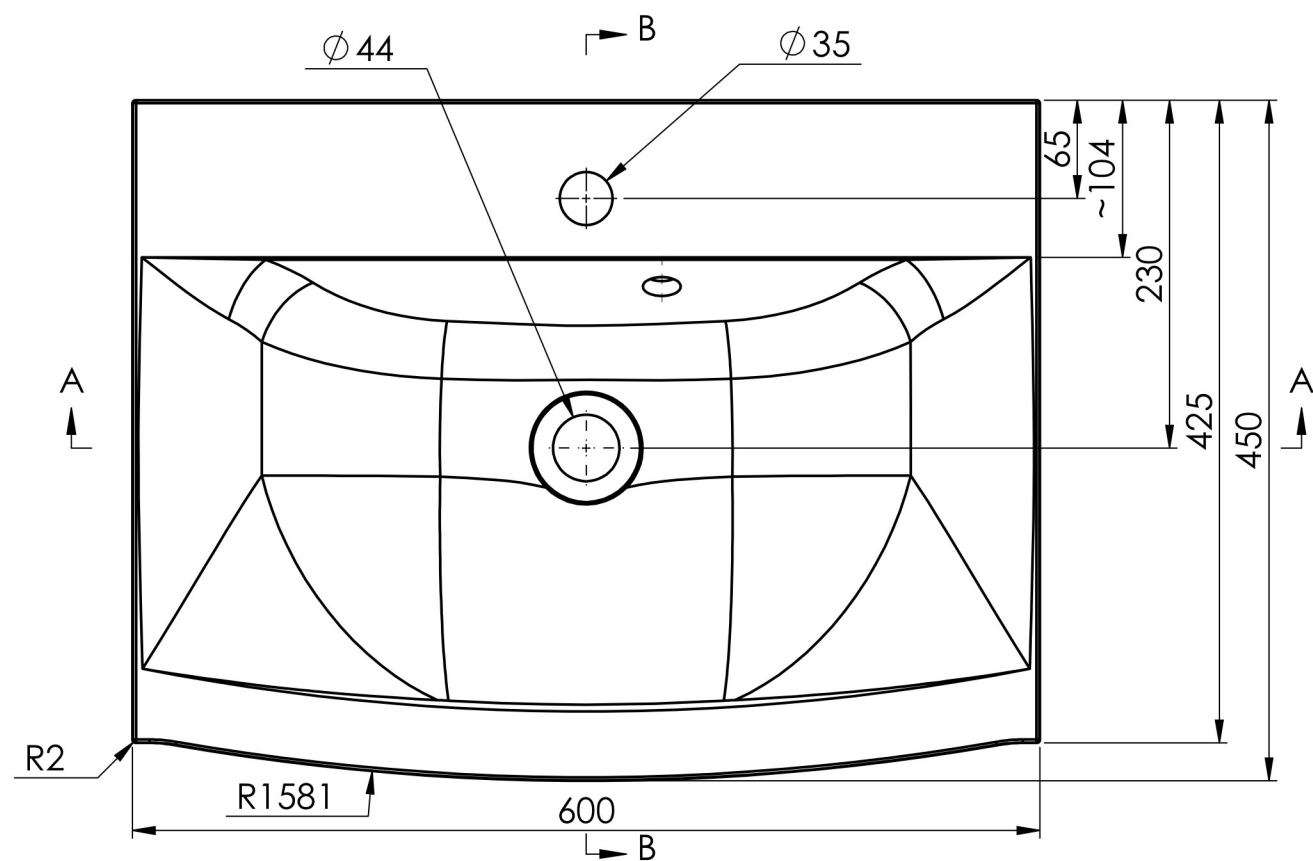

Ø 65 Flat area Bottom view

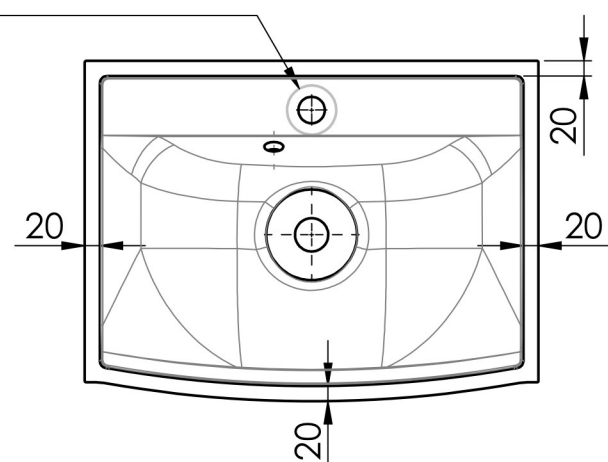

JESI 600 C