

TOLERANCE +3/-3 mm

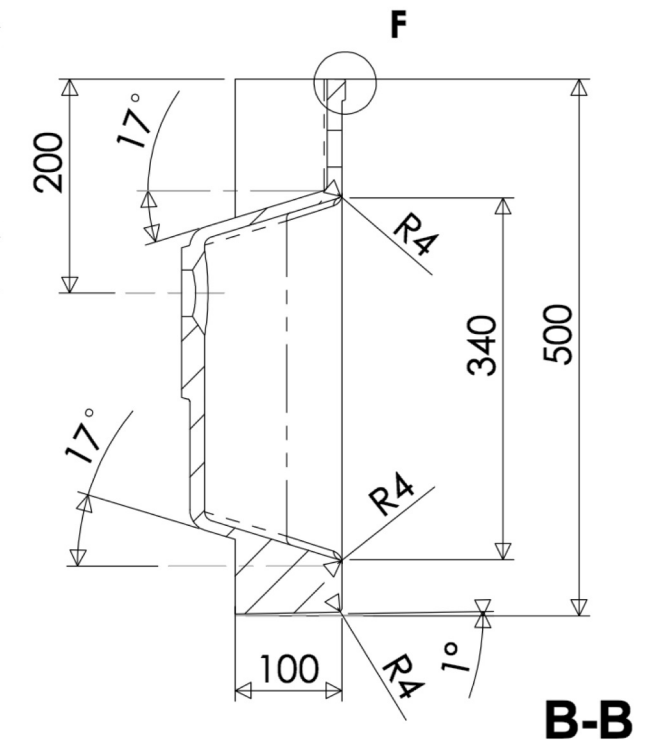
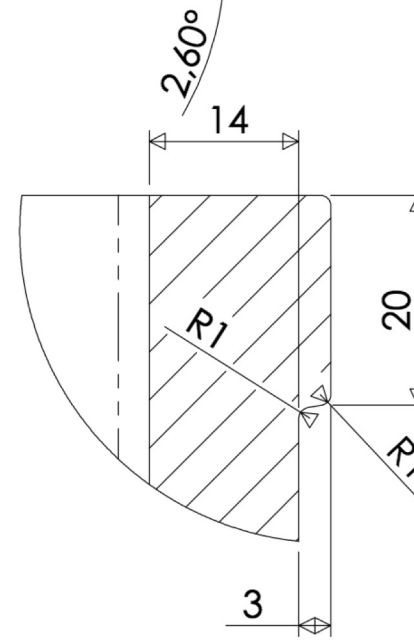
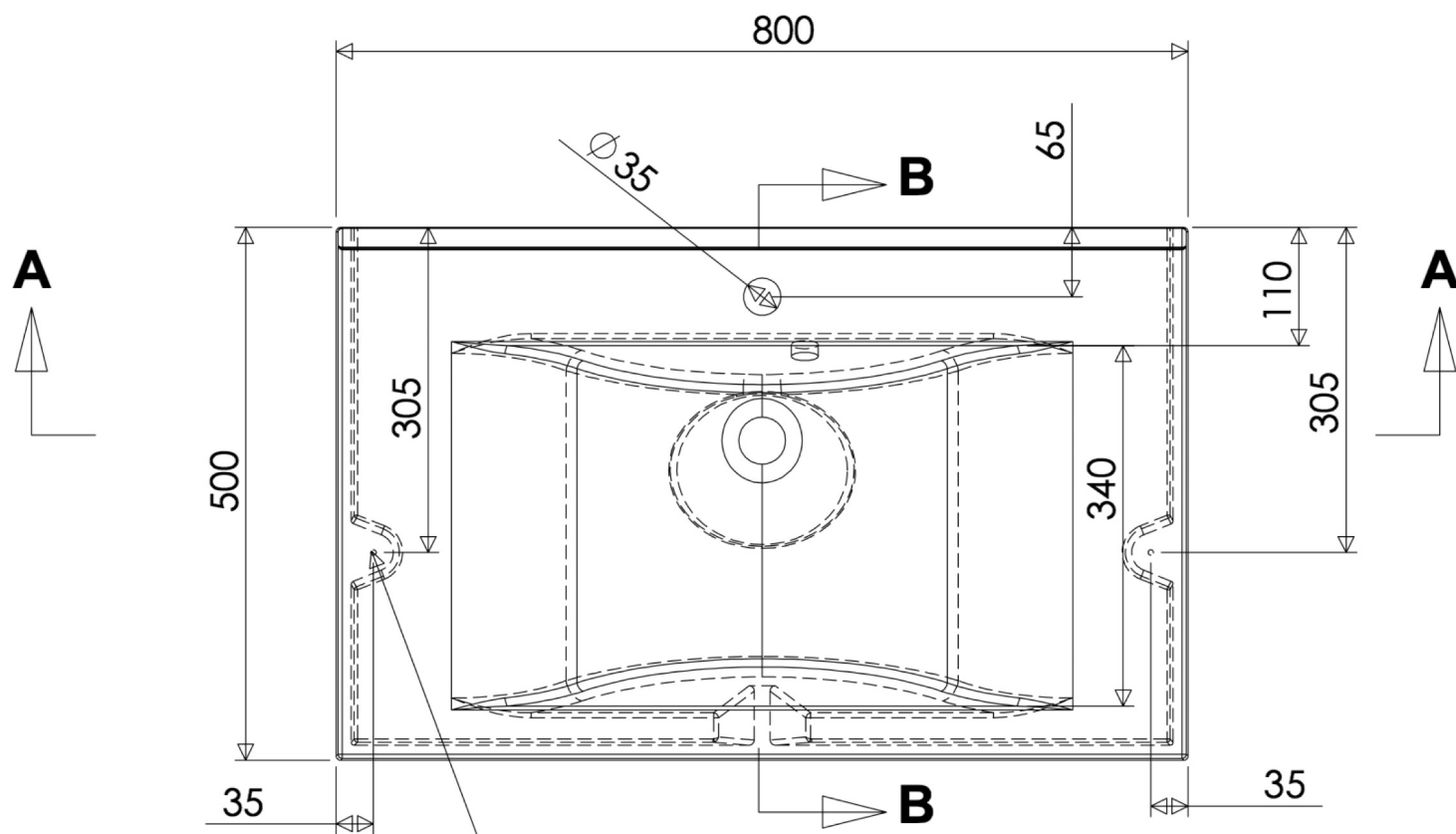

Nylonbussning M5 (2x)

LYRA 800 C